



Colour TV Service Manual

www.rtv-horvat-dj.hr

Model Group: 21LAS1

CHASSIS: 8821

**MODEL:
21LAS1/BN**

CONTENT

GENERAL DESCRIPTION.....	4
CONNECTOR VIEW	5
SAFETY INSTRUCTIONS	5
CIRCUIT ADJUSTMENTS.....	6
FAULT FINDING TREES, DIAGRAMS AND OVERVIEWS.....	12
VARIOUS PARAMETERS OF INTEGRATED CIRCUIT	25
THE BUS DATA FOR TMPA8803	25
ELECTRICAL PARTS LIST.....	28
CIRCUIT DIAGRAM	37

GENERAL DESCRIPTION

AKTP01 /02 chassis series are applied A14T02/A14T02a respectively which uses mainly TOSHIBA' advanced UOC-ultimate chip TMPA8803/8821 and I²C-bus controlled IC With combination of micro controller and small signal processor, the TMPA8803/8821 series feature high-integration, high-performance-to-price ratio and high-reliability and advanced functions with fewer external components, which provide much convenience for manufacturing and technical service.

Figure 1: shows the block diagram of AKTP01 (A14T02).

Table 1: provides A14T02 mainly ICs and functions.

Figure 2: shows the whole set power supply system for AKTP01 (A14T02).

Figure 3: shows the system control circuit of AKTP01 (A14T02).

Table 1: A14T02 mainly ICs and functions

Position	Type	Function Description
N204	TMPA8803/23/21	Micro controller and small signal processor (UOC)
N901	ST24C16-W	EEPROM
N701	LA4267	Sound power amplifier
N402	LA78040	Vertical scan output stage circuit
N203	LC4053B/CD4053B	AV1/AV2 Switch

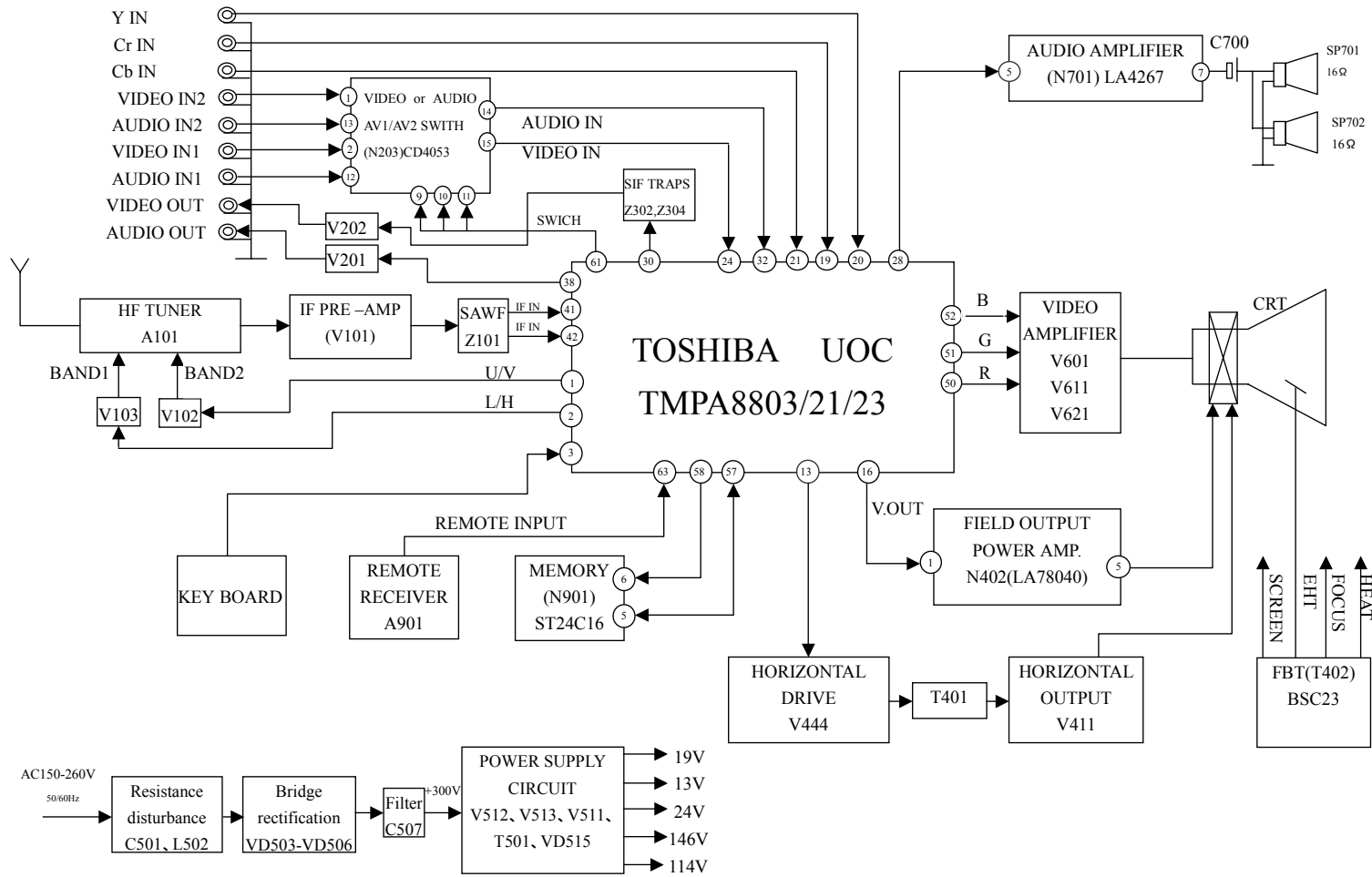

SAFETY INSTRUCTION

WARNING: BEFORE EXAMINING AND SERVICING THIS CHASSIS, READ CAREFULLY THE FOLLOWING SAFETY INSTRUCTIONS.

X-RAY RADIATION PRECAUTION

1. The EHT must be checked every time the receiver is serviced to ensure that the CRT does not emit X-ray radiation as result of excessive EHT voltage. The nominal EHT for this receiver is 22KV at zero beam current (minimum brightness) operating at AC 220V. The maximum EHT voltage permissible in any operating circumstances must not exceed 25KV. When checking the EHT, use the High Voltage Check procedure in this manual using an accurate EHT voltmeter.
2. The only source of X-RAY radiation in this receiver is the CRT. To prevent X-ray radiation, you should use the same type of CRT when replacing it.
3. Some components used in this receiver have safety-related characteristics preventing the CRT from emitting X-ray radiation. For continued safety, replacement component should only be made after referring the Product Safety notice below.

SAFETY PRECAUTION

1. The high voltage in the TV reaches to 22KV when the TV is in operation. Be more careful during opening the back cover.
 - a. The high voltage existing in the TV is very dangerous. Refer servicing to qualified personnel only.
 - b. Before removing the high voltage cap. Discharge the anode of the CRT and the chassis in case of electric shock.
 - c. Wear a pair of goggles when handling the CRT to avoid broken pieces damaging your eyes.
 - d. Do not hold the CRT neck in case of causing damage to the CRT.
2. When the power cord needs replacing, use the same one as that provided by AKIRA factory.
3. Voltage exists between the hot and cold ground when TV is in operation. Install a separation transformer during repairing or connecting to any tester for the sake of safety. The power of the separation transformer should be beyond rated overall power.
4. When replacing a burnout fuse, use the one with the same specifications as the original.
5. When replacing old wire, wind new one round the shaft to weld. When replacing components with safety in performance, use the same type as that specified by AKIRA and install it in the former way.
6. Never place wire near high-temperature or high-voltage components.

SAFETY CAUTIONS FOR PRODUCTS

Many electric and mechanical components in AKTP01 /02 chassis have special safety performances, which are always neglected. Even if replacing them with some components with the same voltage and power, you can not get effective protection to X-ray. In the circuit diagram, these special electric

components are indicated by the special mark  and on the shadow. When replacing any of them, use the one with the same specifications as the original's. Otherwise, it may cause X-ray radiation and damage to overall safety.

CIRCUIT ADJUSTMENTS

GENERAL INFORMATIONS

All adjustment are thoroughly checked and corrected when the receiver leaves the factory. Therefore the receiver should operate normally and produce proper color and B/W pictures upon installation. However, several minor adjustments may be required depending on the particular location in which the receiver is operated.

This receiver is shipped completely in carton. Carefully draw out the receiver from the carton and remove all packing materials. Power cord into a convenient 220 volts 50 Hz AC two pin power outlet. Turn the receiver ON. Check and adjust all the customer controls such as BRIGHTNESS, CONTRAST and COLOUR Controls to obtain natural color or B/W picture.

AUTOMATIC DEGAUSSING

A degaussing coil is mounted around the picture tube so that external degaussing after moving the receiver is normally unnecessary, providing the receiver is properly degaussed upon installation. The degaussing coil operates for about 1 second after the power to the receiver is switched ON. If the set is moved or faced in a different direction, the power switch must be switched off at least 30 minutes in order that the automatic degaussing circuit operates properly. Should the chassis or parts of the cabinet become magnetized to cause poor color purity, use an external-degaussing coil. Slowly move the degaussing coil around the faceplate of the picture tube, the side and front of the receiver and slowly withdraw the coil to a distance of about 2m before disconnecting it from AC source. If color shading still persists, perform the COLOUR PURITY ADJUSTMENT and CONVERGENCE ADJUSTMENTS procedures.

ADJUSTMENT MODE

Item	B+ adjustment, TV signal receiving
	AKTP01/02 chassis
Measuring Equipment	TV SG (Signal Generator) Digital multi-meter
Preparation Before Adj.	The set is turned on Connect the TV SG to RF input terminal of the set.

ADJUSTMENT PROCEDURE

1. Turn RP551 potentiometer to adjust B+ to specified voltage.
2. Check voltages for video out, vertical out, circuit work and audio power out as follow:-

	Voltage (volt)		Tolerance
	14 inch	21 inch	
+B	114	110	$\pm 2V$
Video Out	145	188	$\pm 5V$
Vertical Out	26	26	$\pm 1V$
Circuit Work	13	13	$\pm 1V$
Audio Power Out	19	19	$\pm 1V$

3. TV signal receiving
 - a. Press MENU key, to select POS.MEMORY item.
Press V+ or V- key, to select SEARCH or AUTOMEMORY item, press P+ key to start searching.
 - b. Press P+ or P- key to inspect the set if there is channel skipped, if so, searching again by SEARCH as above described.

Item	TV system adapting & AV in/output inspection
	AKTP01/02 chassis
Measuring Equipment	SG (with NTSC3.58). User remote controller Dual trace oscilloscope
Preparation before Adj.	Input TV and AV signal

Inspection procedure

1. Input the TV signal which system is designated in technical specification
2. Switch TV system to the set by pressing SYS key on user remote controller according to the TV system in SG. The picture and sound must be normal.
3. Press TV/AV key, to select AV input. The picture and sound must be normal
4. AV output inspection. Load a 75Ω resistor to VIDEO output terminal, 1Vp-p video output signal that is from TV signal should be observed on the oscilloscope. Load a 10K resistor to AUDIO output terminal, 0.7Vp-p audio output signal that is from TV should be observed on the oscilloscope.

Item	Focus adjustment
	AKTP01/02 chassis
Measuring Equipment	SG
Preparation before Adj.	Brightness, contrast and color should be set in standard

Adjustment procedure

1. Receive the cross-hatch pattern signal
2. Turn the focus adjusting VR watching the screen and adjust the vertical line of mark to make the most thin. Then the focus adj. VR is set as close low voltage side as possible.
Stop the focus adj. VR at the point that focus is a bit worse at once, turn back to the left and then turn back to the right a little again.

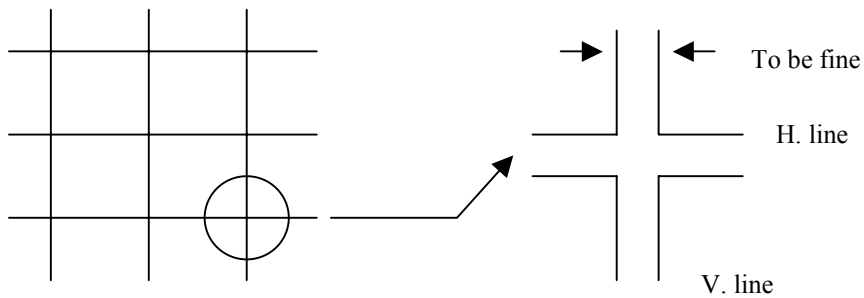

Magnified drawing of part



Item	White balance adjustment
	AKTP01/02 chassis
Measuring Equipment	SG and white balance meter No.1 service remote controller
Preparation before Adj.	Warm up the set for more than 30 min. Brightness, contrast and color should be set in standard

Adjustment procedure

1. Receive the monoscope pattern signal.
2. Press G (G.DRIVE) key and B (B.DRIVE) key on No.1 service remote controller to select G-DRV and B-DRV respectively, then press + or – key to adjust the white balance at the directed value (which is according to the specification of factory's adjustment)
3. Press R+ or R-, G+ or G- and B+ or B- key respectively to adjust the white balance of low light until the white balance of high and low light is good

Item	RF. AGC adjustment
	AKTP01/02 chassis
Measuring Equipment	SG and digital multi meter No.5 service remote controller
Preparation before Adj.	Connect a digital multi meter to TP101 point on the chassis

Adjustment procedure

1. Receive the color bar signal that is 87.5% modulation and 60dBu level
2. Press RF AGC key on No.5 service remote controller to select RF. AGC adjustment, press + or – key to adjust the voltage of RF AGC to $6.2 \pm 0.05V$ that is read on the digital multi meter.





Item	Vertical height, linearity and Hor. position adjustment
	AKTP01/02 chassis
Measuring Equipment	SG No.2 and No.3 service remote controllers
Preparation before Adj.	Brightness, contrast and color should be set in standard

Adjustment procedure

1. Receive the 5-circles pattern signal that is 50HZ vertical frequency
2. Press V-LINE, V-SIZE, V-CENT and H-CENT key on NO.2 service remote controller respectively to select the vertical linearity, height, center (position) and horizontal center (position) adjustment, and then press + or - key to adjust the value of them respectively according to factory's specification.
3. Receive the 5-circles pattern signal that is 60HZ vertical frequency
4. Press V-LINE, V-SIZE, V-CENT and H-CENT key on NO.3 service remote controller separately to adjust the vertical linearity, height, center and horizontal center as above item 3.

Item	OSD position adjustment
	AKTP01/02 chassis
Measuring Equipment	No.1 and No.5 service remote controller
Preparation before Adj.	Brightness, contrast and color should be set in standard

Adjustment procedure

1. Press D-MODE key on No.1 service remote controller to set the set into design mode adjustment
2. Press  or  key to select OSD item, press  or  key to adjust the OSD to the center position on the screen or press RF AGC key on No.5 service remote controller and press + or - key to adjust the OSD position.
3. Press D-MODE key again to quit design mode adjustment.

Item	The functions of the set inspection
	TD46 chassis
Measuring Equipment	SG User remote controller and No.
Preparation Before Adj.	The set is turned on

Inspection procedure

1. Receive the Philips pattern signal.
2. Press PIC key on user remote controller to call the menu as adjusting picture quality. Adjust color, brightness, contrast, sharpness and tint (in NTSC) respectively and all adjustment should be right.
3. Press V+ key to increase the sound volume, no distortion heard at maximum level, press V- key to decrease the sound volume, no sound heard at minimum level.
4. Press POWER key to switch the set into standby status, at mean time the manufactory adjustment mode is cancelled.
5. Press POWER key again, the set should work in normal receiving mode.
6. Press  (mute), DISP (display), PP and SLEEP key respectively, the relevant function should be normal.
7. Press S-OUT key on No.5 service remote controller to set default value that stored in E²PROM on the chassis for product shipment.

FAULT FINDING TREE, DIAGRAMS AND OVERVIEW

1. Three-None (no raster, no picture, no sound)
This failure is mainly caused by big-power circuit such as power supply, horizontal scanning, vertical scanning.
The detail checking and repairing steps are as follow.

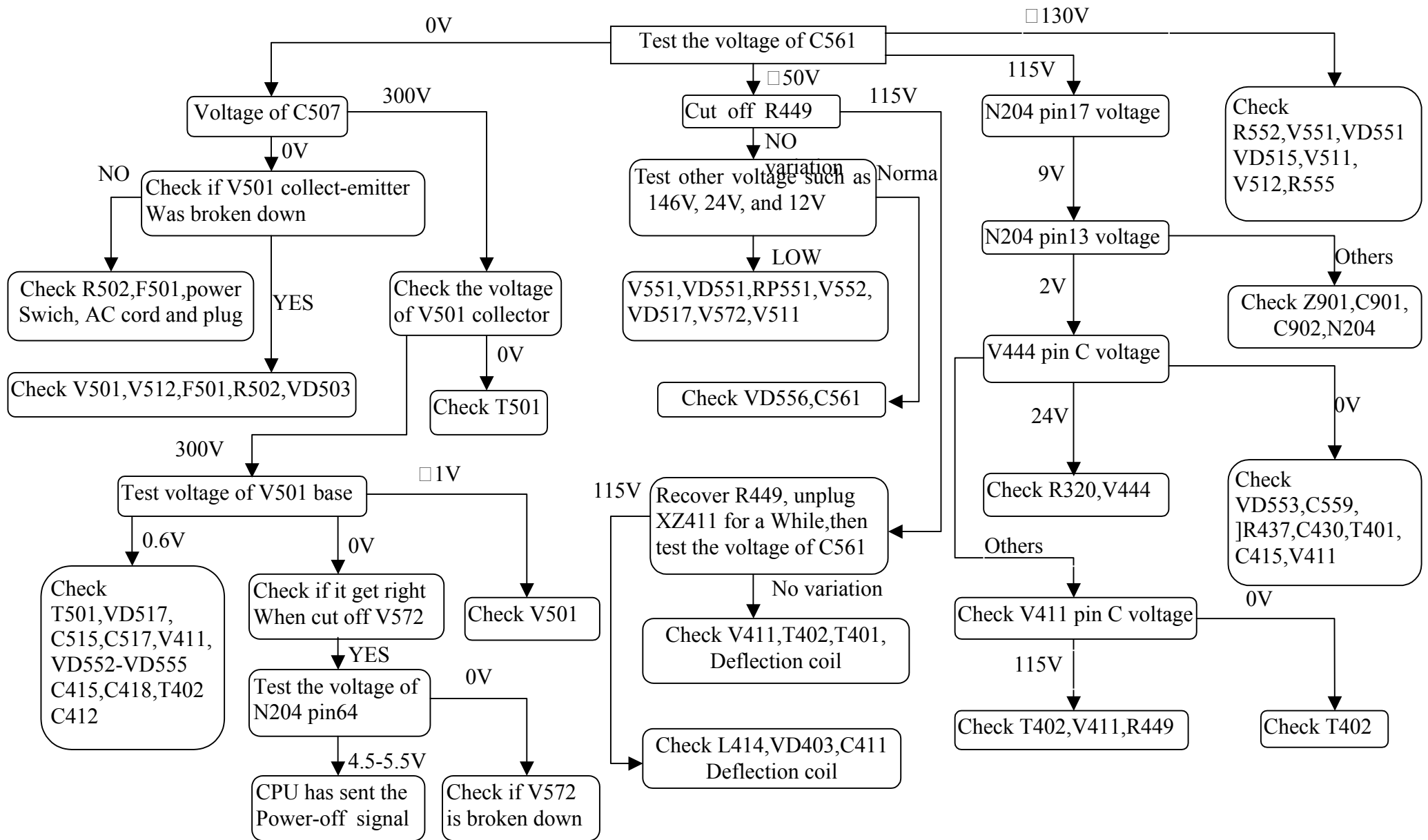

2. B Two-None (no picture, no sound)

The failure shows that the set does not display the picture but it has noise wave or blue background or OSD on the screen. This means that the circuits of power supply, horizontal scanning, vertical scanning and video amplification are normal and they are not considered in the repairing. The failures are mainly in the small signal processing circuits.

Before checking these circuits, a kind of practical test method is introduced. It is called “Signal-input way”. The detail is described as follow: We can use the resistance function of an analog multimeter, connect the red pole (negative in ohm scope) on the circuit board ground, then touch softly the test point with another pole (black pole) in ohm scope meanwhile observe the reactivity on the output device.

Note : In the TV test, we mainly observe the noise wave on the CRT and listen to the noise voice liking as “Ka....Ka” from the loudspeakers.

- a. No picture (see the diagram on next page).

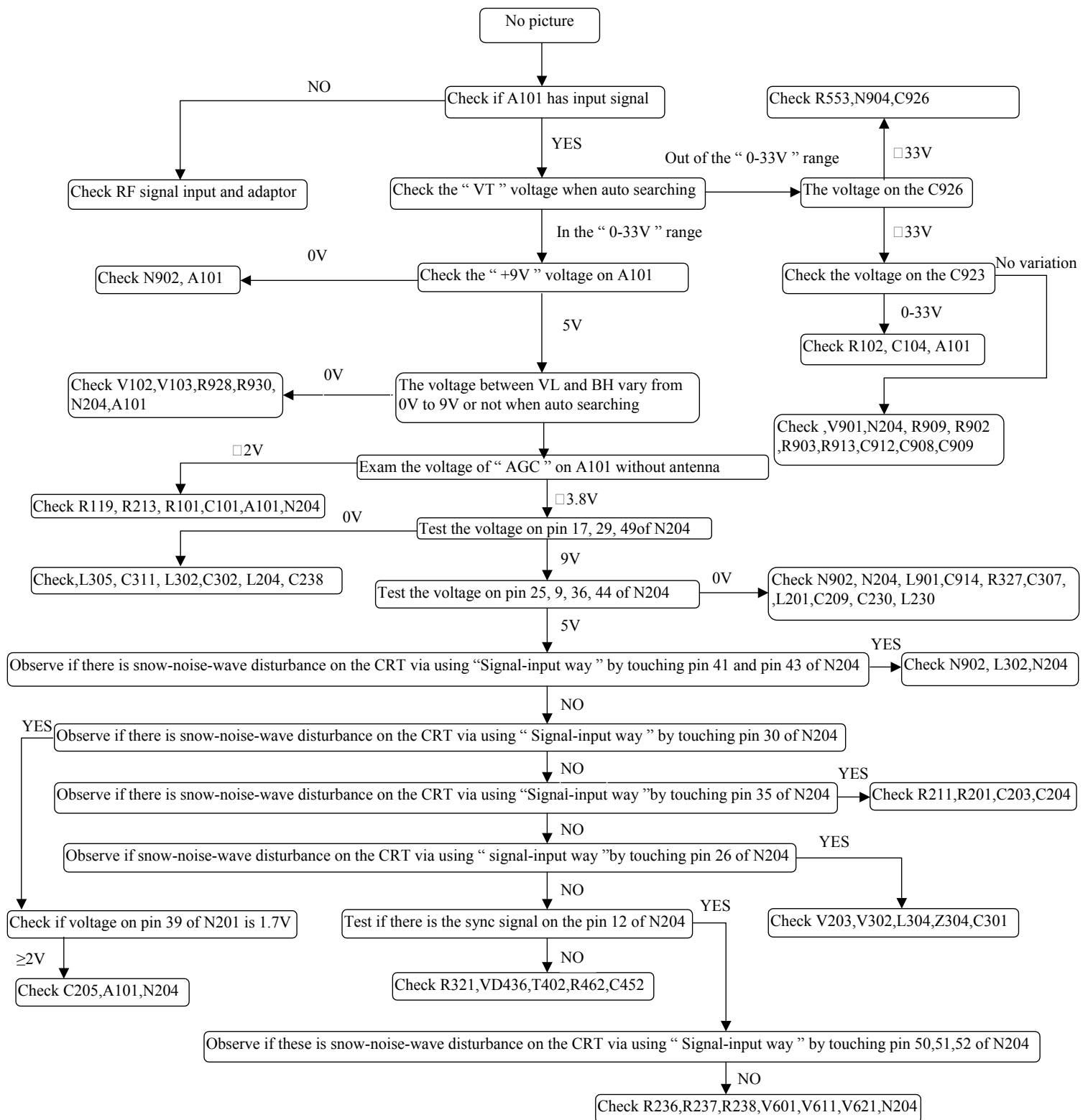

b. No sound

In this kind of failure, first of all we should observe if there is the picture on the CRT. It proves the small signal circuit to work correctly with the picture on the CRT and we only check the sound signal processing and sound amplification circuit. The repairing method (B1) may be referred without picture. The detail checking and repairing steps are as follow.

Note:

Before repairing, assure that the volume is on and the state of set is in "TV". Please see the diagram on next page.

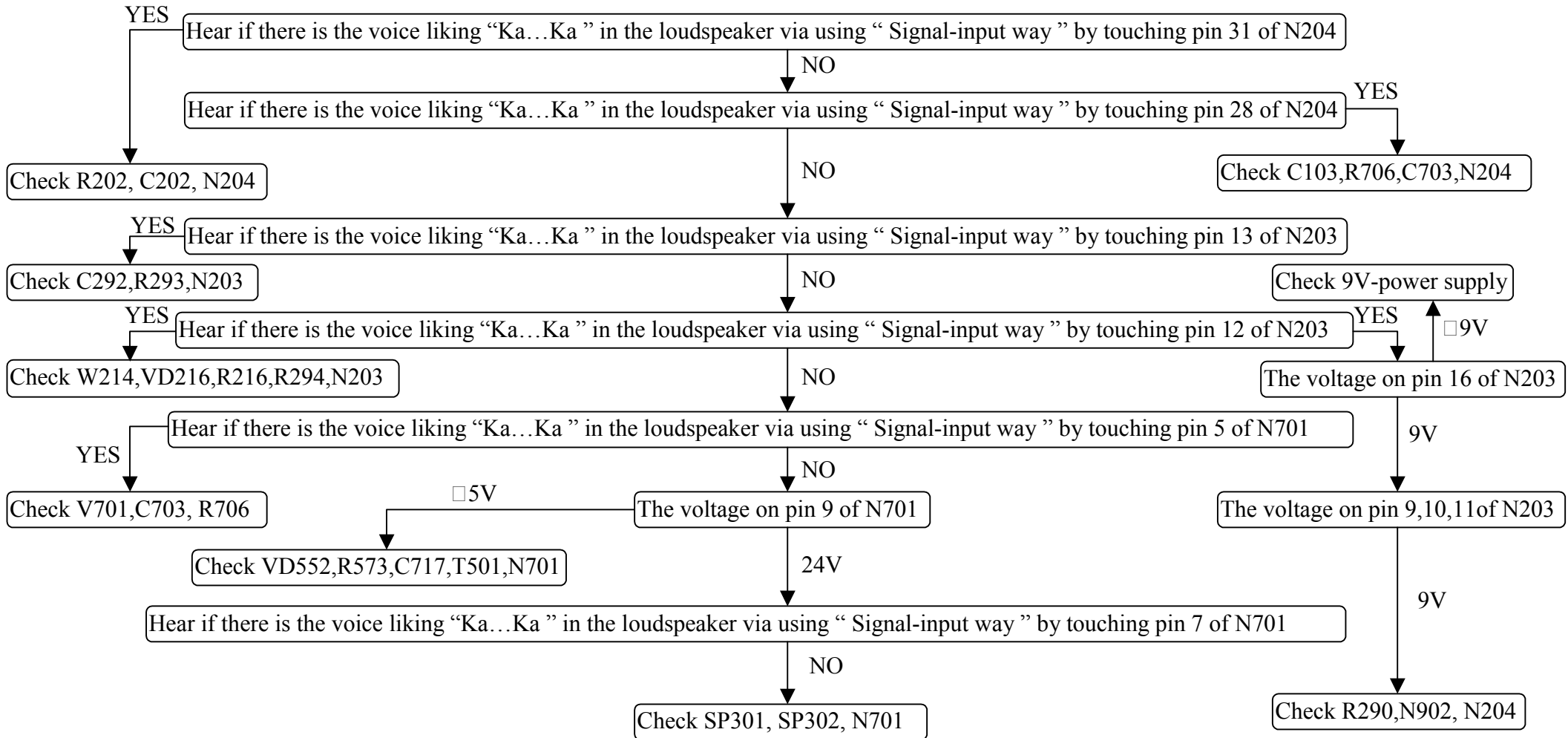

- c. Only horizontal line in the middle of the screen
If vertical deflection circuit does not work, this kind of failure will happen. In deflection yoke, there only has horizontal sweeping, the electron beam in the CRT only moves in the horizontal orientation, so form this failure.
(While checking horizontal and vertical deflection circuit' s failure, we have better to use an oscilloscope.)

Please see the diagram on next page.

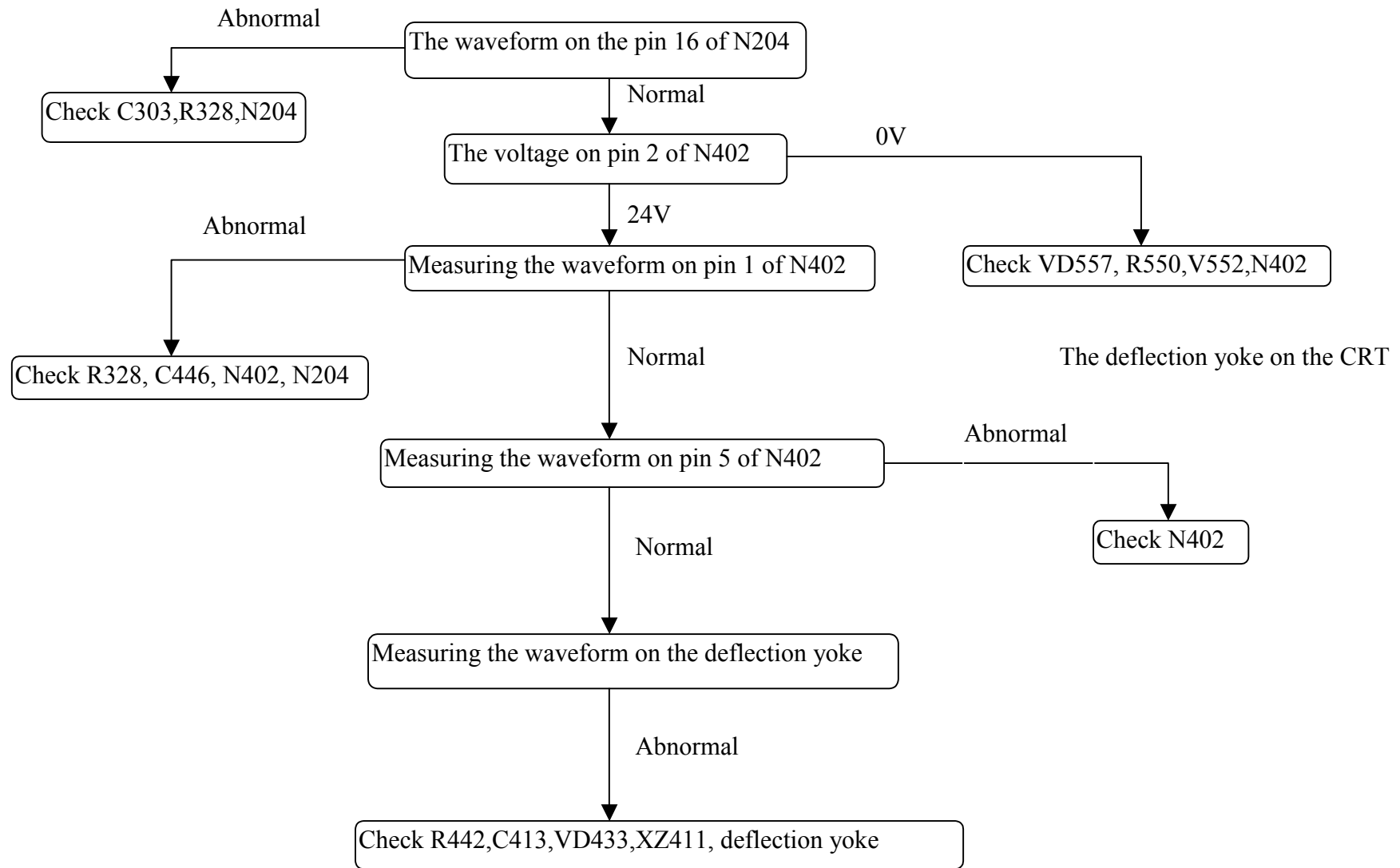

- d. Only vertical line in the middle of the screen
This is a dangerous failure. It probably causes flashover and smoking inside the set. Don't let your TV work for a long time as this failure appears. Because the electron beam can not move in the horizontal orientation, the failure should be in the horizontal deflection circuit. We mainly check the open-circuit fault in horizontal deflection circuit. The detail checking and repairing steps are as follow:

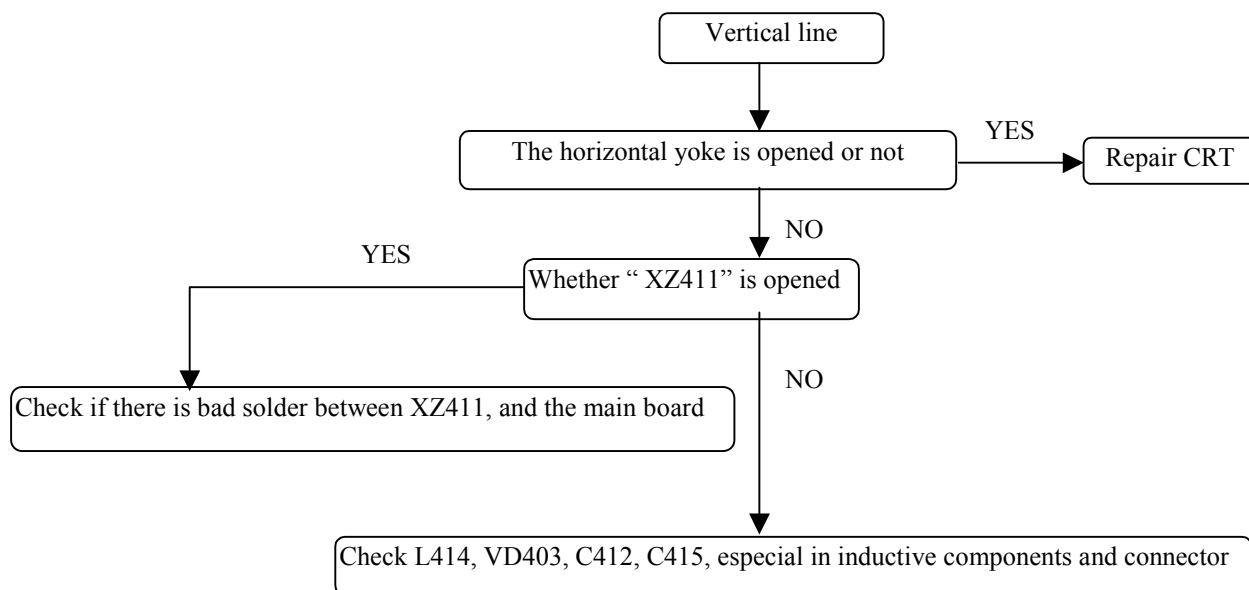

- e. UOC does not work
In television, remote-control system is similar with the computer system. In theory, it can work if it holds two conditions as follow:
- 1) The power supply: In general, it is 5V, the error is not above 10% and the disturbance pulse is as small as possible.
 - 2) The clock pulse: In TMPA88XX circuit, the clock pulse is generated by pin6 / pin7 of N204 and 8M crystal oscillator.

Television's remote-control system also needs reset circuit that can preset the values in internal register. The circuit around pin6 of N204 is called auto-reset circuit. If UOC detects errors in resetting, it will come to the state of programme protected. The detail checking and repairing steps are as follow:

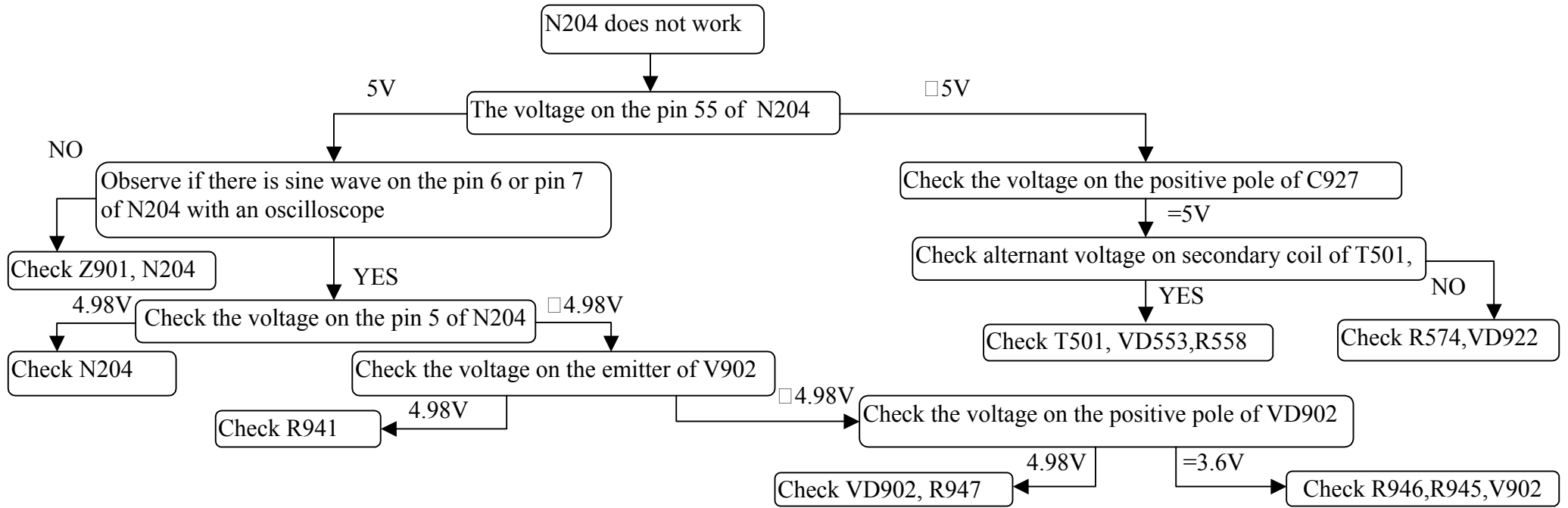

f. No OSD (On Screen Display)

This failure is usually caused by the circuit of character generated and located. Most of the reasons are that the horizontal and vertical flyback pulse signals do not come to UOC.

We can judge this failure by measuring the wave of the character in an oscilloscope. The detail checking and repairing steps are as follows:

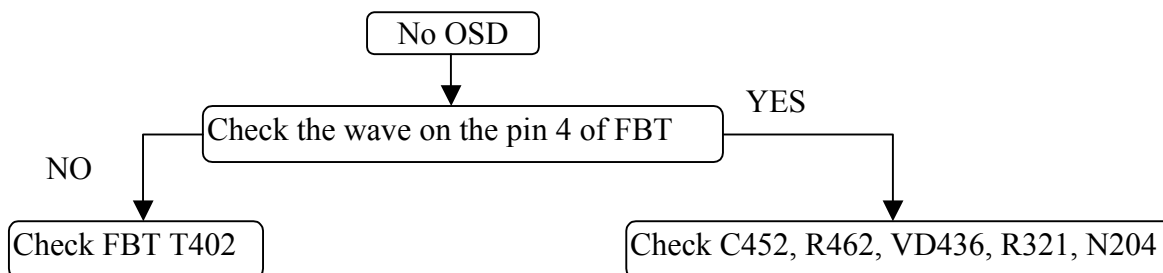

VARIOUS PARAMETERS OF INTEGRATED CIRCUIT

A: Pin functions of N204 (TmpA8803/23/21)

Pin	Symbol	I/O	Function
1	BAND1	Out	BAND data output 1
2	BAND2	Out	BAND data output 2
3	KEY	In	Key input
4	VSS	-	GND connection
5	RESET	In	Reset signal input
6	XIN	In	8 MHz oscillator connecting
7	XOUT	Out	8 MHz oscillator connecting
8	TEST	In	GND connection
9	VDD	In	5V power supply
10	VSS	-	GND connection
11	VSS	-	GND connection
12	FBP in	In	Input terminal for FBP
13	H out	Out	Output terminal for Horizontal driving pulse
14	HAFC 1	-	Terminal To be connected capacitor for H AFC filter
15	V saw	-	Terminal To be connected capacitor to generate V saw signal
16	V out	Out	Output terminal for Vertical driving pulse
17	HVcc	-	Vcc terminal for DEF circuit
18	NC	-	SECAM
19	Cb in	In	Input terminal for Cb signal
20	Y in	In	Input terminal for Y signal
21	Cr in	In	Input terminal for Cr signal
22	TV GND	-	GND terminal for Digital block
23	C in	In	Input terminal for Chroma signal
24	V2 in	In	Input terminal for Video signal
25	TV DVcc	-	Vcc terminal for Digital block
26	V1 in	In	Input terminal for Video signal
27	ABCL	In	Input terminal for ABL/ACL control
28	AU out	Out	Output terminal for Audio signal
29	IF Vcc 9V	-	Vcc for terminal for IF Circuit
30	TV out	Out	Output terminal for detected PIF signal
31	SIF out	Out	Output terminal for detected SIF signal
32	Ext AU in	In	Input terminal for External Audio signal
33	H correct/SIF in	In	Input terminal for H correction and SIF
34	DC NF	Out	Terminal to be connected capacitor for DC Negative Feedback from SIF Det output
35	PIF PLL	-	Terminal to be connected with loop filter for PIF PLL. This terminal voltage is controlled PIF VCO frequency.
36	IF Vcc 5V	-	Vcc terminal for IF circuit. Supply 5V.
37	Reg Fil	-	Terminal to be connected capacitor for stabilizing internal bias.
38	Deempha	-	Terminal to be connected capacitor for SIF Det De-Emphasis.
39	IF AGC	-	Terminal to be connected with IF AGC filter.
40	IF GND	-	GND terminal for IF circuit.
41	IF in	In	Input terminals for IF signals.
42	IF in	In	Input terminals for IF signals.
43	RF AGC		Output terminal for RF AGC control level.
44	TV YC Vcc	-	Vcc terminal for Y/C circuit. Supply 5V.
45	Monitor out	Out	Output terminal for CVBS or Y signal selected by BUS(Video SW).

Pin	Symbol	I/O	Function
46	Black Det	-	Terminal to be connected with Black Det filter for black stretch.
47	Chroma PLL	-	Terminal to be connected with APC filter for chroma demodulation.
48	IK in	In	Input terminal to sense ACB cathode current.
49	RGB Vcc	-	Vcc terminal for RGB circuit. Supply 5V.
50	R out	Out	Output terminal for R signal.
51	G out	Out	Output terminal for G signal.
52	B out	Out	Output terminal for B signal.
53	TV AGND	-	GND terminal for Analog block.
54	VSS	-	GND connection
55	VDD	In	5V power supply
56	VIDEO1/2	Out	Video 1 or 2 selection control
57	SDA1	I/O	IIC-BUS SDA1
58	SCL1	I/O	IIC-BUS SCL1
59	System	Out	System
60	VT	Out	VT output
61	MUTE	Out	Mute Output
62	H.SYNC	In	Horizontal sync signal input
63	REMOTE	In	Remote controller signal input
64	POWER	I/O	Power control & Check, On=Hi-Z(input),Off=L(output)

B: Pin functions of N701 (LA4266/67)

Pin	Symbol	I/O	Function
1	NC		
2	NC		
3	Filter		Mute input
4	PRE GND		
5	IN	In	Sound input
6	NF		
7	OUT	Out	Sound output
8	Power GND		
9	VCC		Power supply
10	NC		

C: Pin functions of N402 (LA78040)

Pin	Symbol	I/O	Function
1	V.IN	In	Inverting input
2	VCC		Power supply
3	PUMP UP		Pump up out
4	GND		
5	V.OUT	Out	Vertical output
6	VCC2		Output stage VCC
7	NON INV IN	In	Non inv input

THE BUS DATA FOR TMPA8803

No	Adjustment Item	Adjustment Function	Type Data
1	RCUT	Red Dard Balance	5E
2	GCUT	Green Dark Balance	72
3	BCUT	Blue Dark Balance	7D
4	GDRV	Green light Balance	3B
5	BDRV	Blue light Balance	3E
6	CNTX	Sub Contrast Max	7F
7	BRTC	Sub-bright Centre	40
8	COLC	Sub Color Center(NTSC)	40
9	TNTC	Sub Tint Center	40
10	COLP	Sub Color Center(PAL Difference)	00
11	COLS	Sub Color Center(SECAM)	40
12	SCOL	Sub Color	07
13	SCNT	Sub Contrast	0B
14	CNTC	Sub Contrast Center	50
15	CNTN	Sub Contrast min	08
16	BRTX	Sub-bright max(difference)	35
17	BRTN	Sub-bright min(difference)	25
18	COLX	Sub color max(difference)	3F
19	COLN	Sub color min	00
20	TNTX	Sub tint max(difference)	28
21	TNTN	Sub tint min(difference)	28
22	ST3	Sub sharp center(3.58NTSC TV)	20
23	SV3	Sub sharp center(3.58NTSC AV)	20
24	ST4	Sub sharp center(OTHER TV)	20
25	SV4	Sub sharp center(OTHER AV)	20
26	SVD	DVD sharp center	26
27	ASSH	Factory Data	07
28	SHPX	Sub sharpness max(difference)	38
29	SHPN	Sub sharpness min(difference)	15
30	TXCX	Text RGB contrast max	1F
31	RGCN	Text RGB contrast min	1F
32	ABL	ABL Data	37
33	DCBS	A part of Video data in detail	33
34	CLTO	The data when TV mode&Sound SYS!=M	0B
35	CLTM	The data when TV mode&Sound SYS!=M	4B
36	CLVO	The data when YUV mode&Sound SYS!=M	4B
37	CLVD	The data when YUV mode&Sound SYS!=M	4B
38	DEF	A part of DEF COMP data in detail	01
39	AKB	AKB SYSTEM	00
40	SECD	SECAM mode 0:OFF center 1: ON 35kHz	18
41	HPOS	Horizontal center of 50 Hz	0A
42	VP50	Vertical centering of 50 Hz	06
43	HIT	Vertical amplitude of 50 Hz	2C
44	HPS	Horizontal centering difference of 60 Hz	03
45	VP60	Vertical centering difference of 60 Hz	02

No	Adjustment Item	Adjustment Function	Type Data
46	HITS	Vertical amplitude deflection of 60Hz	FF
47	VLIN	Vertical line of 50 Hz	0B
48	VSC	Vertical S correction/50 Hz	07
49	VLIS	Vertical line deflection of 60 Hz	00
50	VSS	Vertical S correction/60 Hz	00
51	SBY	SECAM B-Y Black	08
52	SRY	SECAM R-Y Black	08
53	BRTS	Sub bright (difference)	00
54	RAGC	RF AGC	25
55	HAFC	AFC gain	09
56	V25	Volume 25%	3D
57	V50	Volume 50%	57
58	V100	Volume 100%	74
59	MUTT	Y-MUTE SOFT START	00
60	STAT	CONTORAST UP FOR SOFT START	00
61	FLG0	FLAGS FOR IF	52
62	FLG1	FLAGS	04
63	REFP	REF Pulse Position	00
64	RSNS	R SENS	00
65	GSNS	G SENS	00
66	BSNS	B SENS	00
67	MOD	Factory Data	30
68	STBY	VCD/IF STANDBY	00
69	SVM	SVM	00
70	VBLK	V BLK Start/Stop	00
71	VCEN	Factory Data	27
72	HSIZ	Factory Data	20
73	PRBR	Factory Data	20
74	TRUM	Factory Data	10
75	ECCT	Factory Data	10
76	ECCB	Factory Data	10
77	EHT	Factory Data	24
78	UCOM	Miciom Control	00
79	PYNX	Factory Data	2E
80	PYNN	Factory Data	18
81	PYXS	Factory Data	22
82	PYNS	Factory Data	1E
83	RCUTS	FOR YcbCr R CUTOFF	10
84	GCUTS	FOR YcbCr G CUTOFF	00
85	BCUTS	FOR YcbCr B CUTOFF	10
86	GDRVS	FOR YcbCr G DRIVE	00
87	BDRVS	FOR YcbCr B DRIVE	00
88	NOIS	H AFC CONTROL	01
89	AOPT	AKB OPTION	00
90	AV OPT	AV OPTION	06
91	OPT2	Factory Data	3C
92	WAIT TIME	Factory Data	57
93	CUR CEN	Factory Data	A0

No	Adjustment Item	Adjustment Function	Type Data
94	CUR STEP	Factory Data	02
95	AUSTP	When Mute off ,Vol.ATT up step number	04
96	MODE0	Factory Data	9D
97	MODE1	Factory Data	03
98	OSDF	OSD width	53
99	OSD	OSD position	10
100	OPT	Factory Data	E7

NOTE:

The data provided in the form provides to consult only!

ELECTRICAL PARTS LIST

PRODUCT SAFETY NOTE:

Products marked with a ! have special characteristics important to safety. Before replacing any of these components, read carefully the product safety notice in this service manual. Don't degrade the safety of the product through improper servicing.

NOTE: parts that not assigned part numbers(.....) are not available.

Tolerance of Capacitors and Resistors are noted with the following symbols.

C	±0.25%
D	±0.5%
F	±1%
G	±2%
J	±5%
K	±10%
M	±20%
N	±30%
Z	+80/-20%

Ref. No	Part No.	Name	Specification
R101	D10B683J-T	Carbon resistor	RT13-1/6W-68KΩ±5%
R444	D10B4R7J-T	Carbon resistor	RT13-1/6W-4.7Ω±5%
R701	D10B4R7J-T	Carbon resistor	RT13-1/6W-4.7Ω±5%
R113	D10B330J-T	Carbon resistor	RT13-1/6W-33Ω±5%
R203	D10B101J-T	Carbon resistor	RT13-1/6W-100Ω±5%
R206	D10B101J-T	Carbon resistor	RT13-1/6W-100Ω±5%
R207	D10B101J-T	Carbon resistor	RT13-1/6W-100Ω±5%
R208	D10B101J-T	Carbon resistor	RT13-1/6W-100Ω±5%
R210	D10B101J-T	Carbon resistor	RT13-1/6W-100Ω±5%
R217	D10B101J-T	Carbon resistor	RT13-1/6W-100Ω±5%
R218	D10B101J-T	Carbon resistor	RT13-1/6W-100Ω±5%
R219	D10B101J-T	Carbon resistor	RT13-1/6W-100Ω±5%
R220	D10B101J-T	Carbon resistor	RT13-1/6W-100Ω±5%
R231	D10B101J-T	Carbon resistor	RT13-1/6W-100Ω±5%
R292	D10B101J-T	Carbon resistor	RT13-1/6W-100Ω±5%
R301	D10B101J-T	Carbon resistor	RT13-1/6W-100Ω±5%
R305	D10B101J-T	Carbon resistor	RT13-1/6W-100Ω±5%
R306	D10B101J-T	Carbon resistor	RT13-1/6W-100Ω±5%
R323	D10B101J-T	Carbon resistor	RT13-1/6W-100Ω±5%
R609	D10B101J-T	Carbon resistor	RT13-1/6W-100Ω±5%
W214	D10B101J-T	Carbon resistor	RT13-1/6W-100Ω±5%
R201	D10B151J-T	Carbon resistor	RT13-1/6W-150Ω±5%
R404	D10B151J-T	Carbon resistor	RT13-1/6W-150Ω±5%
R601	D10B151J-T	Carbon resistor	RT13-1/6W-150Ω±5%
R611	D10B151J-T	Carbon resistor	RT13-1/6W-150Ω±5%

Ref. No	Part No.	Name	Specification
R621	D10B151J-T	Carbon resistor	RT13-1/6W-150Ω±5%
R106	D10B221J-T	Carbon resistor	RT13-1/6W-220Ω±5%
R107	D10B221J-T	Carbon resistor	RT13-1/6W-220Ω±5%
R310	D10B221J-T	Carbon resistor	RT13-1/6W-220Ω±5%
R205	D10B271J-T	Carbon resistor	RT13-1/6W-270Ω±5%
R236	D10B271J-T	Carbon resistor	RT13-1/6W-270Ω±5%
R237	D10B271J-T	Carbon resistor	RT13-1/6W-270Ω±5%
R238	D10B271J-T	Carbon resistor	RT13-1/6W-270Ω±5%
R325	D10B271J-T	Carbon resistor	RT13-1/6W-270Ω±5%
R326	D10B271J-T	Carbon resistor	RT13-1/6W-270Ω±5%
R240	D10B561J-T	Carbon resistor	RT13-1/6W-560Ω±5%
R320	D10B561J-T	Carbon resistor	RT13-1/6W-560Ω±5%
R941	D10B561J-T	Carbon resistor	RT13-1/6W-560Ω±5%
R241	D10B681J-T	Carbon resistor	RT13-1/6W-680Ω±5%
R517	D10B681J-T	Carbon resistor	RT13-1/6W-680Ω±5%
R704	D10B751J-T	Carbon resistor	RT13-1/6W-750Ω±5%
R604	D10B821J-T	Carbon resistor	RT13-1/6W-820Ω±5%
R614	D10B821J-T	Carbon resistor	RT13-1/6W-820Ω±5%
R624	D10B821J-T	Carbon resistor	RT13-1/6W-820Ω±5%
R119	D10B102J-T	Carbon resistor	RT13-1/6W-1KΩ±5%
R214	D10B102J-T	Carbon resistor	RT13-1/6W-1KΩ±5%
R324	D10B102J-T	Carbon resistor	RT13-1/6W-1KΩ±5%
R603	D10B102J-T	Carbon resistor	RT13-1/6W-1KΩ±5%
R613	D10B102J-T	Carbon resistor	RT13-1/6W-1KΩ±5%
R623	D10B102J-T	Carbon resistor	RT13-1/6W-1KΩ±5%
R902	D10B102J-T	Carbon resistor	RT13-1/6W-1KΩ±5%
R904	D10B102J-T	Carbon resistor	RT13-1/6W-1KΩ±5%
R925	D10B102J-T	Carbon resistor	RT13-1/6W-1KΩ±5%
R115	D10B152J-T	Carbon resistor	RT13-1/6W-1.5KΩ±5%
R480	D10B152J-T	Carbon resistor	RT13-1/6W-1.5KΩ±5%
R578	D10B152J-T	Carbon resistor	RT13-1/6W-1.5KΩ±5%
R608	D10B152J-T	Carbon resistor	RT13-1/6W-1.5KΩ±5%
R610	D10B152J-T	Carbon resistor	RT13-1/6W-1.5KΩ±5%
R944	D10B152J-T	Carbon resistor	RT13-1/6W-1.5KΩ±5%
R946	D10B152J-T	Carbon resistor	RT13-1/6W-1.5KΩ±5%
R242	D10B222J-T	Carbon resistor	RT13-1/6W-2.2KΩ±5%
R708	D10B272J-T	Carbon resistor	RT13-1/6W-2.7KΩ±5%
R202	D10B332J-T	Carbon resistor	RT13-1/6W-3.3KΩ±5%
R230	D10B332J-T	Carbon resistor	RT13-1/6W-3.3KΩ±5%
R330	D10B332J-T	Carbon resistor	RT13-1/6W-3.3KΩ±5%
R108	D10B392J-T	Carbon resistor	RT13-1/6W-3.9KΩ±5%
R249	D10B392J-T	Carbon resistor	RT13-1/6W-3.9KΩ±5%
R251	D10B392J-T	Carbon resistor	RT13-1/6W-3.9KΩ±5%
R446	D10B392J-T	Carbon resistor	RT13-1/6W-3.9KΩ±5%
R916	D10B392J-T	Carbon resistor	RT13-1/6W-3.9KΩ±5%
R928	D10B392J-T	Carbon resistor	RT13-1/6W-3.9KΩ±5%
R930	D10B392J-T	Carbon resistor	RT13-1/6W-3.9KΩ±5%
R945	D10B472J-T	Carbon resistor	RT13-1/6W-4.7KΩ±5%

Ref. No	Part No.	Name	Specification
R443	D10B562J-T	Carbon resistor	RT13-1/6W-5.6KΩ±5%
R511	D10B562J-T	Carbon resistor	RT13-1/6W-5.6KΩ±5%
R920	D10B562J-T	Carbon resistor	RT13-1/6W-5.6KΩ±5%
R1002	D10B562J-T	Carbon resistor	RT13-1/6W-5.6KΩ±5%
R322	D10B822J-T	Carbon resistor	RT13-1/6W-8.2KΩ±5%
R947	D10B822J-T	Carbon resistor	RT13-1/6W-8.2KΩ±5%
R102	D10B103J-T	Carbon resistor	RT13-1/6W-10KΩ±5%
R255	D10B103J-T	Carbon resistor	RT13-1/6W-10KΩ±5%
R290	D10B103J-T	Carbon resistor	RT13-1/6W-10KΩ±5%
R321	D10B103J-T	Carbon resistor	RT13-1/6W-10KΩ±5%
R423	D10B103J-T	Carbon resistor	RT13-1/6W-10KΩ±5%
R448	D10B103J-T	Carbon resistor	RT13-1/6W-10KΩ±5%
R562	D10B103J-T	Carbon resistor	RT13-1/6W-10KΩ±5%
R579	D10B103J-T	Carbon resistor	RT13-1/6W-10KΩ±5%
R912	D10B103J-T	Carbon resistor	RT13-1/6W-10KΩ±5%
R918	D10B103J-T	Carbon resistor	RT13-1/6W-10KΩ±5%
R919	D10B103J-T	Carbon resistor	RT13-1/6W-10KΩ±5%
R938	D10B103J-T	Carbon resistor	RT13-1/6W-10KΩ±5%
R939	D10B103J-T	Carbon resistor	RT13-1/6W-10KΩ±5%
R942	D10B103J-T	Carbon resistor	RT13-1/6W-10KΩ±5%
R248	D10B123J-T	Carbon resistor	RT13-1/6W-12KΩ±5%
R706	D10B123J-T	Carbon resistor	RT13-1/6W-12KΩ±5%
R1003	D10B123J-T	Carbon resistor	RT13-1/6W-12KΩ±5%
R213	D10B153J-T	Carbon resistor	RT13-1/6W-15KΩ±5%
R216	D10B153J-T	Carbon resistor	RT13-1/6W-15KΩ±5%
R293	D10B153J-T	Carbon resistor	RT13-1/6W-15KΩ±5%
R328	D10B153J-T	Carbon resistor	RT13-1/6W-15KΩ±5%
R447	D10B153J-T	Carbon resistor	RT13-1/6W-15KΩ±5%
R607	D10B153J-T	Carbon resistor	RT13-1/6W-15KΩ±5%
R7007	D10B153J-T	Carbon resistor	RT13-1/6W-15KΩ±5%
R224	D10B223J-T	Carbon resistor	RT13-1/6W-22KΩ±5%
R252	D10B223J-T	Carbon resistor	RT13-1/6W-22KΩ±5%
R481	D10B223J-T	Carbon resistor	RT13-1/6W-22KΩ±5%
R515	D10B223J-T	Carbon resistor	RT13-1/6W-22KΩ±5%
R551	D10B223J-T	Carbon resistor	RT13-1/6W-22KΩ±5%
R575	D10B223J-T	Carbon resistor	RT13-1/6W-22KΩ±5%
R576	D10B223J-T	Carbon resistor	RT13-1/6W-22KΩ±5%
R909	D10B223J-T	Carbon resistor	RT13-1/6W-22KΩ±5%
R232	D10B333J-T	Carbon resistor	RT13-1/6W-33KΩ±5%
R903	D10B333J-T	Carbon resistor	RT13-1/6W-33KΩ±5%
R913	D10B333J-T	Carbon resistor	RT13-1/6W-33KΩ±5%
R943	D10B333J-T	Carbon resistor	RT13-1/6W-33KΩ±5%
R1001	D10B333J-T	Carbon resistor	RT13-1/6W-33KΩ±5%
R450	D10B473J-T	Carbon resistor	RT13-1/6W-47KΩ±5%
R246	D10B683J-T	Carbon resistor	RT13-1/6W-68KΩ±5%
R243	D10B104J-T	Carbon resistor	RT13-1/6W-100KΩ±5%
R473	D10B104J-T	Carbon resistor	RT13-1/6W-100KΩ±5%
R7003	D10B104J-T	Carbon resistor	RT13-1/6W-100KΩ±5%
R233	D10B224J-T	Carbon resistor	RT13-1/6W-220KΩ±5%

Ref. No	Part No.	Name	Specification
R211	D10B334J-T	Carbon resistor	RT13-1/6W-330K Ω \pm 5%
R247	D10B564J-T	Carbon resistor	RT13-1/6W-560K Ω \pm 5%
R632	D10C330J-T	Carbon resistor	RT14-1/4W-33 Ω \pm 5%
R519	D10C221J-T	Carbon resistor	RT14-1/4W-220 Ω \pm 5%
R960	D10C471J-T	Carbon resistor	RT14-1/4W-470 Ω \pm 5%
R245	D10C182J-T	Carbon resistor	RT14-1/4W-1.8K Ω \pm 5%
R526	D10C222J-T	Carbon resistor	RT14-1/4W-2.2K Ω \pm 5%
R559	D10C392J-T	Carbon resistor	RT14-1/4W-3.9K Ω \pm 5%
R557	D10C472J-T	Carbon resistor	RT14-1/4W-4.7K Ω \pm 5%
R424	D10C153J-T	Carbon resistor	RT14-1/4W-15K Ω \pm 5%
R522	D10C153J-T	Carbon resistor	RT14-1/4W-15K Ω \pm 5%
R555	D10C473J-T	Carbon resistor	RT14-1/4W-47K Ω \pm 5%
R556	D10C473J-T	Carbon resistor	RT14-1/4W-47K Ω \pm 5%
R554	D10C154J-T	Carbon resistor	RT14-1/4W-150K Ω \pm 5%
R445	D10D1R8J-T	Carbon resistor	RT15-1/2W-1.8 Ω \pm 5%
R327	D10D221J-T	Carbon resistor	RT15-1/2W-220 Ω \pm 5%
R442	D10D331J-T	Carbon resistor	RT15-1/2W-330 Ω \pm 5%
R407	D10D102J-T	Carbon resistor	RT15-1/2W-1K Ω \pm 5%
R560	D10D332J-T	Carbon resistor	RT15-1/2W-3.3K Ω \pm 5%
R606	D10D332J-T	Carbon resistor	RT15-1/2W-3.3K Ω \pm 5%
R616	D10D332J-T	Carbon resistor	RT15-1/2W-3.3K Ω \pm 5%
R626	D10D332J-T	Carbon resistor	RT15-1/2W-3.3K Ω \pm 5%
R462	D10D682J-T	Carbon resistor	RT15-1/2W-6.8K Ω \pm 5%
R552	D10D473J-T	Carbon resistor	RT15-1/2W-47K Ω \pm 5%
R520	D10D104J-T	Carbon resistor	RT15-1/2W-100K Ω \pm 5%
R521	D10D104J-T	Carbon resistor	RT15-1/2W-100K Ω \pm 5%
R561	D10D224J-T	Carbon resistor	RT15-1/2W-220K Ω \pm 5%
R413	S10E472J-S(A)	Metal oxide resistor	RY16/RY21-1W-4.7K Ω \pm 5%
R600	S10F1R0J-C	Metal oxide resistor	RY17/RY21-2W-2.2 Ω \pm 5%
R564	S10E471J-C	Metal oxide resistor	RY16/RY21-1W-470 Ω \pm 5%
R605	S10E123J-C	Metal oxide resistor	RY16/RY21-1W-12K Ω \pm 5%
R615	S10E123J-C	Metal oxide resistor	RY16/RY21-1W-12K Ω \pm 5%
R625	S10E123J-C	Metal oxide resistor	RY16/RY21-1W-12K Ω \pm 5%
R525	S10F680J-C	Metal oxide resistor	RY17/RY21-2W-68 Ω \pm 5%
R580	S10F680J-C	Metal oxide resistor	RY17/RY21-2W-68 Ω \pm 5%
R574	S10F151J-C	Metal oxide resistor	RY17/RY21-2W-150 Ω \pm 5%
R437	S10F271J-C	Metal oxide resistor	RY17/RY21-2W-270 Ω \pm 5%
R553	S10F123J-C	Metal oxide resistor	RY17/RY21-2W-12K Ω \pm 5%
R565	S10F123J-C	Metal oxide resistor	RY17/RY21-2W-12K Ω \pm 5%
R527	S10G560J-C	Metal oxide resistor	RY18/RY21-3W-56 Ω \pm 5%
R531 !		Glass-Glazed Fixed RES	RI40-1/2W-24M Ω \pm 5%
R558 !	F10DR47J-C	Fuse resistor	RF10-1/2W-0.47 Ω \pm 5%
R550 !	F10D1R0J-C	Fuse resistor	RF10-1/2W-1 Ω \pm 5%
R573 !	F10D1R0J-C	Fuse resistor	RF10-1/2W-1 Ω \pm 5%
R449	W11H3R9K	Wire-wound resistor	RXG6-5W-3.9 Ω -J
R502 !	W10J3R9K	Wire-wound resistor	RXG6-6W-3.9 Ω -J
PS551	P10X180J-C	Thermistor	PTC-180HM
RP501	V11D202B	Potentiometer	WI06-2AA2K Ω
C902	C2CF200J-T	Ceramic capacitor	CC1-06A-CH-50/63V-20pF-J

Ref. No	Part No.	Name	Specification
C315	C2CF220J-T	Ceramic capacitor	CC1-06A-CH-50/63V-22pF-J
C247	C2CF330J-T	Ceramic capacitor	CC1-06A-CH-50/63V-33pF-J
C901	C2CF330J-T	Ceramic capacitor	CC1-06A-CH-50/63V-33pF-J
C602	C2BF101K-T	Ceramic capacitor	CC1-06A-RH-50/63V-100pF-J
C612	C2BF101K-T	Ceramic capacitor	CC1-06A-RH-50/63V-100pF-J
C622	C2BF101K-T	Ceramic capacitor	CC1-06A-RH-50/63V-100pF-J
C235	C2BF181K-T	Ceramic capacitor	CC1-06A-RH-50/63V-180pF-J
C908	C2BF221K-T	Ceramic capacitor	CC1-06A-RH-50/63V-220pF-J
C909	C2BF221K-T	Ceramic capacitor	CC1-06A-RH-50/63V-220pF-J
C912	C2BF221K-T	Ceramic capacitor	CC1-06A-RH-50/63V-220pF-J
C203	C2BF102K-T	Ceramic capacitor	CT1-06A-2B4-50/63V-1000pF-K
C934	C2BF102K-T	Ceramic capacitor	CT1-06A-2B4-50/63V-1000pF-K
C246	C2BF152K-T	Ceramic capacitor	CT1-06A-2B4-50/63V-1500pF-K
C234	C2BF272K-T	Ceramic capacitor	CT1-06A-2B4-50/63V-2700pF-K
C112	C2FF103Z-T	Ceramic capacitor	CT1-08A-2F4-50/63V-0.01uF-Z
C113	C2FF103Z-T	Ceramic capacitor	CT1-08A-2F4-50/63V-0.01uF-Z
C114	C2FF103Z-T	Ceramic capacitor	CT1-08A-2F4-50/63V-0.01uF-Z
C120	C2FF103Z-T	Ceramic capacitor	CT1-08A-2F4-50/63V-0.01uF-Z
C202	C2FF103Z-T	Ceramic capacitor	CT1-08A-2F4-50/63V-0.01uF-Z
C208	C2FF103Z-T	Ceramic capacitor	CT1-08A-2F4-50/63V-0.01uF-Z
C210	C2FF103Z-T	Ceramic capacitor	CT1-08A-2F4-50/63V-0.01uF-Z
C211	C2FF103Z-T	Ceramic capacitor	CT1-08A-2F4-50/63V-0.01uF-Z
C232	C2FF103Z-T	Ceramic capacitor	CT1-08A-2F4-50/63V-0.01uF-Z
C233	C2FF103Z-T	Ceramic capacitor	CT1-08A-2F4-50/63V-0.01uF-Z
C304	C2FF103Z-T	Ceramic capacitor	CT1-08A-2F4-50/63V-0.01uF-Z
C309	C2FF103Z-T	Ceramic capacitor	CT1-08A-2F4-50/63V-0.01uF-Z
C310	C2FF103Z-T	Ceramic capacitor	CT1-08A-2F4-50/63V-0.01uF-Z
C574	C2FF103Z-T	Ceramic capacitor	CT1-08A-2F4-50/63V-0.01uF-Z
C604	C2FF103Z-T	Ceramic capacitor	CT1-08A-2F4-50/63V-0.01uF-Z
C903	C2FF103Z-T	Ceramic capacitor	CT1-08A-2F4-50/63V-0.01uF-Z
C913	C2FF103Z-T	Ceramic capacitor	CT1-08A-2F4-50/63V-0.01uF-Z
C915	C2FF103Z-T	Ceramic capacitor	CT1-08A-2F4-50/63V-0.01uF-Z
C924	C2FF103Z-T	Ceramic capacitor	CT1-08A-2F4-50/63V-0.01uF-Z
C929	C2FF103Z-T	Ceramic capacitor	CT1-08A-2F4-50/63V-0.01uF-Z
C930	C2FF103Z-T	Ceramic capacitor	CT1-08A-2F4-50/63V-0.01uF-Z
C402	C2BP102K-T	Ceramic capacitor	CT1-08C-2B4-500V-1000pF-K
C403	C2BP392K-T	Ceramic capacitor	CT1-08C-2B4-500V-3900pF-K
C452	C2BP392K-T	Ceramic capacitor	CT1-08C-2B4-500V-3900pF-K
C448	C2SP100D-T	Ceramic capacitor	CT1-07-B-500V-10PF-±10%
C503	C2BW102K-O	Ceramic capacitor	CT81-08C-2R-1KV-1000pF-K
C504	C2BW102K-O	Ceramic capacitor	CT81-08C-2R-1KV-1000pF-K
C505	C2BW102K-O	Ceramic capacitor	CT81-08C-2R-1KV-1000pF-K
C506	C2BW102K-O	Ceramic capacitor	CT81-08C-2R-1KV-1000pF-K
C555	C2BW471K-O	Ceramic capacitor	CT81-08C-2R-1KV-470pF-K
C556	C2RX221K-O	Ceramic capacitor	CT81-08C-2R-2KV-220pF-K
C418	C2RX471K-O	Ceramic capacitor	CT81-08C-2R-2KV-470pF-K
VD530	C2RX681K-O	Ceramic capacitor	CT81-08C-2R-2KV-680pF-K
C630	C2EX222Z-O	Ceramic capacitor	CT81-08C-2R-2KV-2200pF-K
C535 !	C2EM102M-O	Ceramic capacitor	CTJ1-AC250V-1000PF-±20%

Ref. No	Part No.	Name	Specification
C291	E20C4R7M-T	Electrolytic Capacitor	CD110-16V-4.7uF -M
C292	E20C4R7M-T	Electrolytic Capacitor	CD110-16V-4.7uF -M
C296	E20C4R7M-T	Electrolytic Capacitor	CD110-16V-4.7uF -M
C293	E20C100M-T	Electrolytic Capacitor	CD110-16V-10uF -M
C294	E20C100M-T	Electrolytic Capacitor	CD110-16V-10uF -M
C306	E20C100M-T	Electrolytic Capacitor	CD110-16V-10uF -M
C558	E20C100M-T	Electrolytic Capacitor	CD110-16V-10uF -M
C603	E20C100M-T	Electrolytic Capacitor	CD110-16V-10uF -M
C605	E20C100M-T	Electrolytic Capacitor	CD110-16V-10uF -M
C218	E20C220M-T	Electrolytic Capacitor	CD110-16V-22uF -M
C102	E20C470M-T	Electrolytic Capacitor	CD110-16V-47uF -M
C238	E20C470M-T	Electrolytic Capacitor	CD110-16V-47uF -M
C240	E20C470M-T	Electrolytic Capacitor	CD110-16V-47uF -M
C244	E20C470M-T	Electrolytic Capacitor	CD110-16V-47uF -M
C295	E20C470M-T	Electrolytic Capacitor	CD110-16V-47uF -M
C307	E20C470M-T	Electrolytic Capacitor	CD110-16V-47uF -M
C914	E20C470M-T	Electrolytic Capacitor	CD110-16V-47uF -M
C916	E20C470M-T	Electrolytic Capacitor	CD110-16V-47uF -M
C920	E20C470M-T	Electrolytic Capacitor	CD110-16V-47uF -M
C230	E20C101M-T	Electrolytic Capacitor	CD110-16V-100uF -M
C243	E20C101M-T	Electrolytic Capacitor	CD110-16V-100uF -M
C302	E20C101M-T	Electrolytic Capacitor	CD110-16V-100uF -M
C702	E20C101M-T	Electrolytic Capacitor	CD110-16V-100uF -M
C704	E20C101M-T	Electrolytic Capacitor	CD110-16V-100uF -M
C927	E20C101M-T	Electrolytic Capacitor	CD110-16V-100uF -M
C928	E20C101M-T	Electrolytic Capacitor	CD110-16V-100uF -M
C209	E20C471M-T	Electrolytic Capacitor	CD110-16V-470uF -M
C222	E20C471M-T	Electrolytic Capacitor	CD110-16V-470uF -M
C311	E20C471M-T	Electrolytic Capacitor	CD110-16V-470uF -M
C571	E20C471M-T	Electrolytic Capacitor	CD110-16V-470uF -M
C201	E20D100MN-T	NON-POLAR Capacitor	CD71-BP-25V-10uF-M
C700	E20D221M	Electrolytic Capacitor	CD110-25V-220uF -M
C557	E20D471M	Electrolytic Capacitor	CD110-25V-470uF -M
C564	E20D471M	Electrolytic Capacitor	CD110-25V-470uF -M
C717	E20D471M	Electrolytic Capacitor	CD110-25V-470uF -M
C433	E20D102M	Electrolytic Capacitor	CD110-25V-1000uF -M
C430	E20E470M-T	Electrolytic Capacitor	CD110-35V-47uF -M
C449	E20E101M-T	Electrolytic Capacitor	CD110-35V-100uF -M
C559	E20E331M	Electrolytic Capacitor	CD110-35V-330uF -M
C565	E20E331M	Electrolytic Capacitor	CD110-35V-330uF -M
C104	E20F0R1MR	Electrolytic Capacitor	CD114-50V-0.1uF -M
C237	E20FR22M-T	Electrolytic Capacitor	CD110-50V-0.22uF -M
C108	E20FR47M-T	Electrolytic Capacitor	CD110-50V-0.47uF -M
C110	E20FR47M-T	Electrolytic Capacitor	CD110-50V-0.47uF -M
C204	E20FR47M-T	Electrolytic Capacitor	CD110-50V-0.47uF -M
C301	E20FR47M-T	Electrolytic Capacitor	CD110-50V-0.47uF -M
C303	E20FR47M-T	Electrolytic Capacitor	CD110-50V-0.47uF -M
C308	E20FR47M-T	Electrolytic Capacitor	CD110-50V-0.47uF -M
C205	E20F1R0M-T	Electrolytic Capacitor	CD110-50V-1uF -M

Ref. No	Part No.	Name	Specification
C215	E20F1R0M-T	Electrolytic Capacitor	CD110-50V-1uF -M
C216	E20F1R0M-T	Electrolytic Capacitor	CD110-50V-1uF -M
C217	E20F1R0M-T	Electrolytic Capacitor	CD110-50V-1uF -M
C236	E20F1R0M-T	Electrolytic Capacitor	CD110-50V-1uF -M
C245	E20F1R0M-T	Electrolytic Capacitor	CD110-50V-1uF -M
C103	E20F2R2M-T	Electrolytic Capacitor	CD110-50V-2.2uF -M
C300	E20F2R2M-T	Electrolytic Capacitor	CD110-50V-2.2uF -M
C443	E20F2R2M-T	Electrolytic Capacitor	CD110-50V-2.2uF -M
C926	E20F2R2M-T	Electrolytic Capacitor	CD110-50V-2.2uF -M
C101	E20F4R7M-T	Electrolytic Capacitor	CD110-50V-4.7uF -M
C206	E20F4R7M-T	Electrolytic Capacitor	CD110-50V-4.7uF -M
C703	E20F4R7M-T	Electrolytic Capacitor	CD110-50V-4.7uF -M
C705	E20F4R7M-T	Electrolytic Capacitor	CD110-50V-4.7uF -M
C411	E21H1R0M-T	Electrolytic Capacitor	CD110-160V-1uF -M
C563	E20H101M	Electrolytic Capacitor	CD110-160V-100uF-M
C562	E20H100M	Electrolytic Capacitor	CD110-160V-10uF -M
C507	E20M101M	Electrolytic Capacitor	CD293-400V-100uF±10%
C231	F20F102J-T	Mylar capacitor	CL11-50V/63V-1000PF-K
C446	F20F222J-T	Mylar capacitor	CL11-50V/63V-2200PF-K
C708	F20F392J-T	Mylar capacitor	CL11-50V/63V-3900PF-K
C305	F20F822J-T	Mylar capacitor	CL11-50V/63V-8200PF-K
C515	F22F123J-T	Mylar capacitor	CL21X-50V/63V-0.012uF-K
C517	F20F223K-T	Mylar capacitor	CL11-50V/63V-0.022uF-K
C514	F20F393K-T	Mylar capacitor	CL11-50V/63V-0.039uF-K
C447	F20F563K-T	Mylar capacitor	CL11-50V/63V-0.056uF-K
C460	F20F104K-T	Mylar capacitor	CL11-50V/63V-0.1uF-K
C461	F20F104K-T	Mylar capacitor	CL11-50V/63V-0.1uF-K
C701	F20F104K-T	Mylar capacitor	CL11-50V/63V-0.1uF-K
C922	F20F104K-T	Mylar capacitor	CL11-50V/63V-0.1uF-K
C923	F20F104K-T	Mylar capacitor	CL11-50V/63V-0.1uF-K
C413	F20G104K-T	Mylar capacitor	CL11-100V-0.1uF-K
C421	F20G104K-T	Mylar capacitor	CL11-100V-0.1uF-K
C444	F20G104K-T	Mylar capacitor	CL11-100V-0.1uF-K
C412	F20J474J	Polypropylene capacitor	CBB21-200V-0.47uF±5%
C415 !	F20Z822J	Polypropylene capacitor	CBB81-1.6KV-8200PF-J
C501 !	F20R224M	Polypropylene capacitor	CBB62-250VAC-0.22uF
L414	LXXX0040	H-linear	LX40
T101	TLXX0018	Coil	D18
L103	L3X11R0K-T	Inductor	LGA0307-1uH-K
L304	L3X18R2K-T	Inductor	LGA0307-8.2uH-K
L101	L3X1150K-T	Inductor	LGA0307-15uH-K
L104	L3X1150K-T	Inductor	LGA0307-15uH-K
L201	L3X1150K-T	Inductor	LGA0307-15uH-K
L230	L3X1150K-T	Inductor	LGA0307-15uH-K
L302	L3X1150K-T	Inductor	LGA0307-15uH-K
L305	L3X1150K-T	Inductor	LGA0307-15uH-K
L901	L3X1150K-T	Inductor	LGA0307-15uH-K
L501 !	LMXX0002	Degaussing coil	
VD515 !	RX0001XX	Photoelectricity coupler	PC817B/C

Ref. No	Part No.	Name	Specification
VD1001	DL0008XX	LED	RED 5mm
VD230	DR0001XX-T	Diode	IS1555/IN4148A
VD232	DR0001XX-T	Diode	IS1555/IN4148A
VD233	DR0001XX-T	Diode	IS1555/IN4148A
VD401	DR0001XX-T	Diode	IS1555/IN4148A
VD514	DR0001XX-T	Diode	IS1555/IN4148A
VD516	DR0001XX-T	Diode	IS1555/IN4148A
VD558	DR0001XX-T	Diode	IS1555/IN4148A
VD601	DR0001XX-T	Diode	IS1555/IN4148A
VD901	DR0001XX-T	Diode	IS1555/IN4148A
VD517	DR0003XX-T	Diode	FR105
VD552	DR0003XX-T	Diode	FR105
VD553	DR0003XX-T	Diode	FR105
VD557	DR0003XX-T	Diode	FR105
VD433	DR0009XX-T	Diode	GP10D/FR104/IN4004
VD434	DR0009XX-T	Diode	GP10D/FR104/IN4004
VD403	DR0010XX-T	Diode	FR107
VD503	DR0015XX-T	Diode	TVR4N/TRM11C
VD504	DR0015XX-T	Diode	TVR4N/TRM11C
VD505	DR0015XX-T	Diode	TVR4N/TRM11C
VD506	DR0015XX-T	Diode	TVR4N/TRM11C
VD556	DR0017XX	Diode	RGP10J
VD554	DR0018XX	Diode	RGP10D
VD555	DR0031XX-T	Diode	TJ1010
VD551	DZ0001XX-T	Diode	RD6.2EB3/HZ7A1
VD922	DZ0002XX-T	Diode	RD5.1EB2/HZ5C1
VD501	DZ0006XX-T	Diode	RD3.6L/HZ4A2
VD902	DZ0006XX-T	Diode	RD3.6L/HZ4A2
VD921	DZ0015XX-T	Diode	RD5.6EB2/HZ6B1
VD216	DZ0011XX-T	Diode	RD9.1EB2/HZ9B2
VD217	DZ0011XX-T	Diode	RD9.1EB2/HZ9B2
VD703	DZ0011XX-T	Diode	RD9.1EB2/HZ9B2
VD436	DZ0004XX-T	Diode	RD10EB2/HZ11C1
N904	IXXX0080	IC	upc574J/CW574
N701	IXXX0180	IC	LA4267 5W
N902	IXXX0118	IC	TA78M09 9V□□
N203	IXXX0120	IC	LC4053B/CD4053B
N204		IC	TMPA8803CPAN-3GV1
N402	IXXX0142	IC	LA78040
N901	IXXX0173	IC	BR ST24C16-W
V230	RXA1015X-T	Audion	2SA1015Y/2SA608/2SA733Q
V232	RXA1015X-T	Audion	2SA1015Y/2SA608/2SA733Q
V233	RXA1015X-T	Audion	2SA1015Y/2SA608/2SA733Q
V302	RXA1015X-T	Audion	2SA1015Y/2SA608/2SA733Q
V511	RXA1015X-T	Audion	2SA1015Y/2SA608/2SA733Q
V602	RXA1015X-T	Audion	2SA1015Y/2SA608/2SA733Q
V902	RXA1015X-T	Audion	2SA1015Y/2SA608/2SA733Q
V570	RXB764XX-T	Audion	2SB764

Ref. No	Part No.	Name	Specification
V552	RXB892XX-T	Audion	2SB892/2SB985T
V101	RXC2216X-T	Audion	2SC2216
V601	RXC2482X	Audion	2SC2482
V611	RXC2482X	Audion	2SC2482
V621	RXC2482X	Audion	2SC2482
V444	RXC2383X-T	Audion	2SC2383-O
V512	RXC3807X	Audion	2SC3807/2SC5070
V501	RXC5287X	Audion	2SD1710/2SC4584/C5586
V102	RXC945XX-T	Audion	2SC945/2SC1815/2SC536E
V103	RXC945XX-T	Audion	2SC945/2SC1815/2SC536E
V201	RXC945XX-T	Audion	2SC945/2SC1815/2SC536E
V202	RXC945XX-T	Audion	2SC945/2SC1815/2SC536E
V203	RXC945XX-T	Audion	2SC945/2SC1815/2SC536E
V231	RXC945XX-T	Audion	2SC945/2SC1815/2SC536E
V551	RXC945XX-T	Audion	2SC945/2SC1815/2SC536E
V571	RXC945XX-T	Audion	2SC945/2SC1815/2SC536E
V572	RXC945XX-T	Audion	2SC945/2SC1815/2SC536E
V701	RXC945XX-T	Audion	2SC945/2SC1815/2SC536E
V901	RXC945XX-T	Audion	2SC945/2SC1815/2SC536E
V411	RXD2499X	Audion	2SD2499/2SD1651
V905	RXD400XX-T	Audion	2SD400D
Z304	FC0007XX	Ceramic trap filter	XT6.0M
Z302	FC0008XX	Ceramic trap filter	XT5.5M
Z101		SAWF	□1339□38.9M
F501 !	FXXX0020	FUSE	2.5A 250V
A1001	RXXX0016	Remote receiver	HS0038
A101	T9XX0330C	Tuner	TDV-3S7-9 470M
SW1001	KXXX0101	Touch switch	PUSH SW.(L:5mm)
SW1002	KXXX0101	Touch switch	PUSH SW.(L:5mm)
SW1003	KXXX0101	Touch switch	PUSH SW.(L:5mm)
SW1004	KXXX0101	Touch switch	PUSH SW.(L:5mm)
SW1005	KXXX0101	Touch switch	PUSH SW.(L:5mm)
SW1006	KXXX0101	Touch switch	PUSH SW.(L:5mm)
Z901	XC0004XX-A	XTLO	8.0M(20P)
	FXXX0020	IRICO	37SX110Y22-DC05

CIRCUIT DIAGRAM

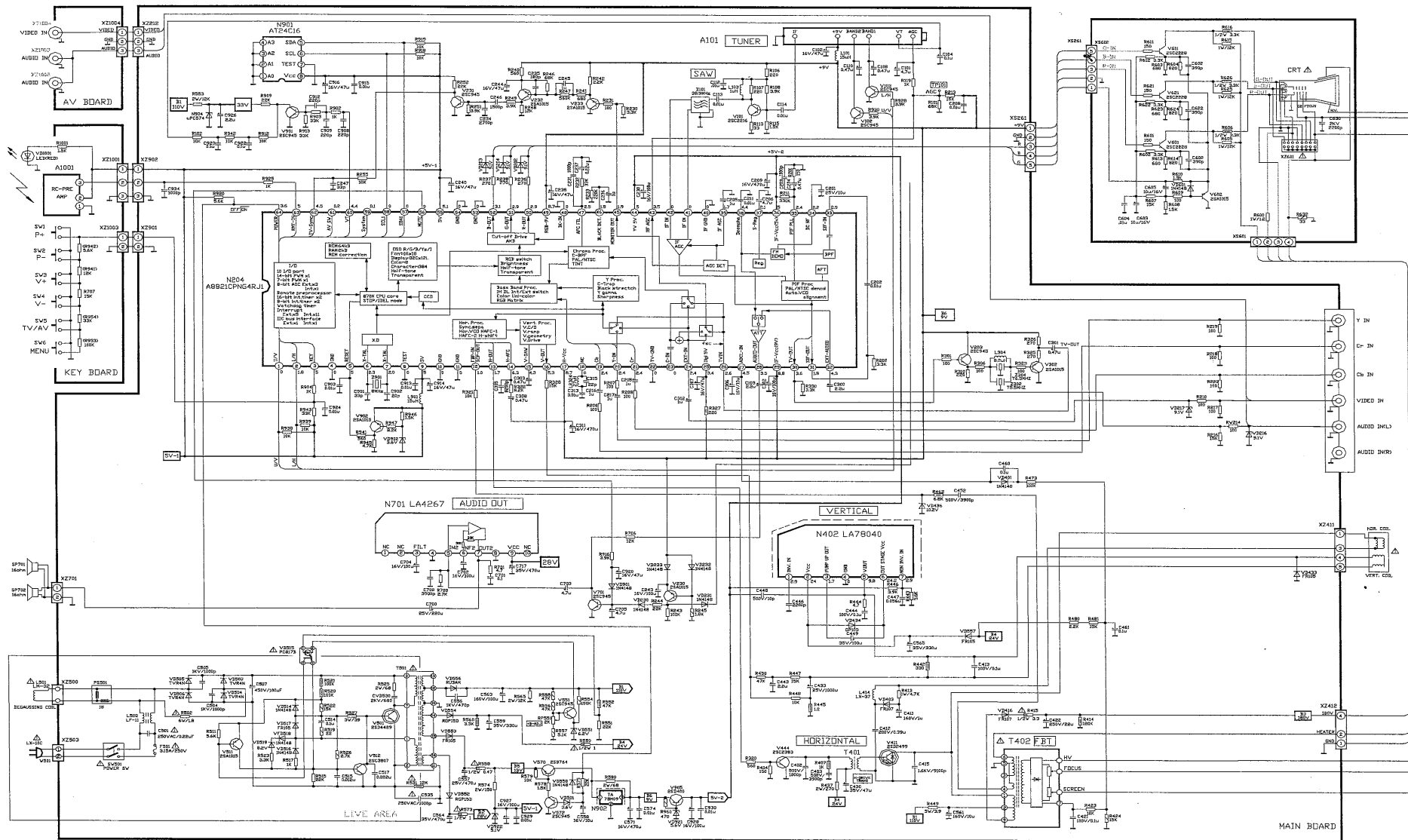

NOTICE
 SINCE THIS IS A BASIC CIRCUIT DIAGRAM THE VALUE OF COMPONENTS ARE SUBJECT TO BE CHANGED FOR IMPROVEMENT.
 CAUTION
 THE COMPONENTS WITH 'Δ' IN THE SCHEMATIC DIAGRAM WHICH HAVE SPECIAL CHARACTERISTICS IMPORTANT FOR SAFETY SHOULD BE REPLACED ONLY WITH TYPE IDENTICAL TO THOSE IN THE ORIGINAL CIRCUIT.

www.rtv-horvat-dj.hr